

Tema 4: Diodos.

Contenidos

4.1 Estructura

4.2 Modelos

4.3 Limitadores

4.4 Rectificadores

4.1 Estructura

Semiconductores Separados

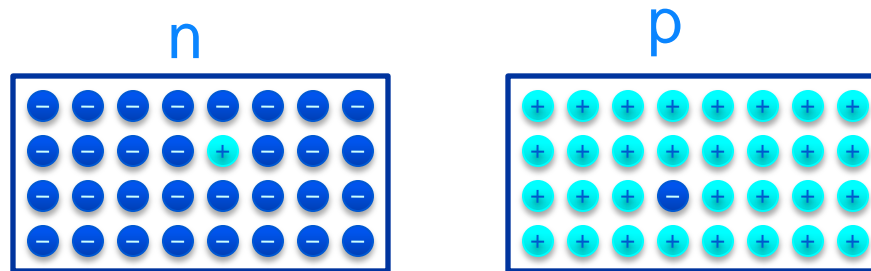

Unión de los semiconductores

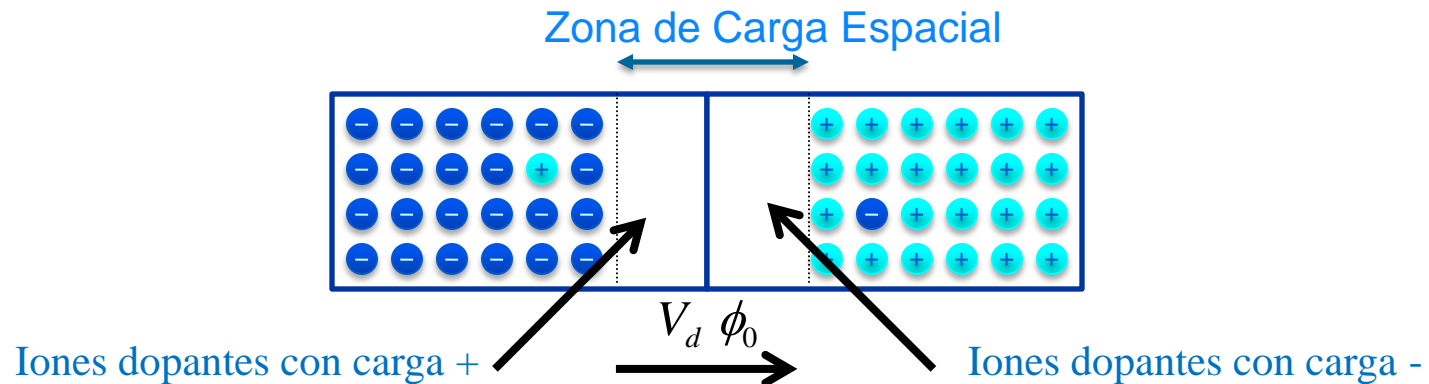

4.1 Estructura

Diodo: Dispositivo formado por dos uniones semiconductoras de tipo p y tipo n o la unión de un semiconductor y un metal

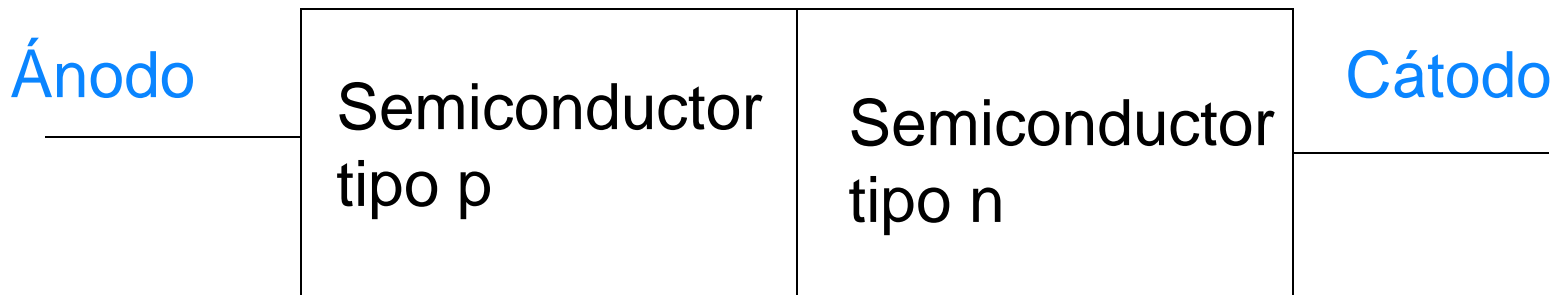

Símbolo

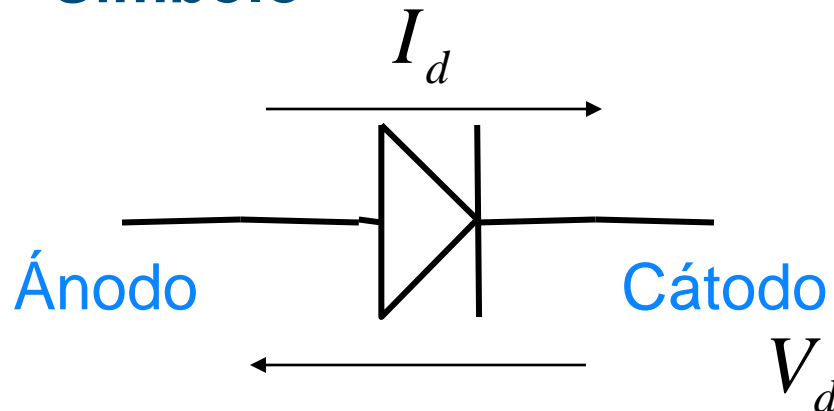

4.1 Estructura

Concentración de Impurezas

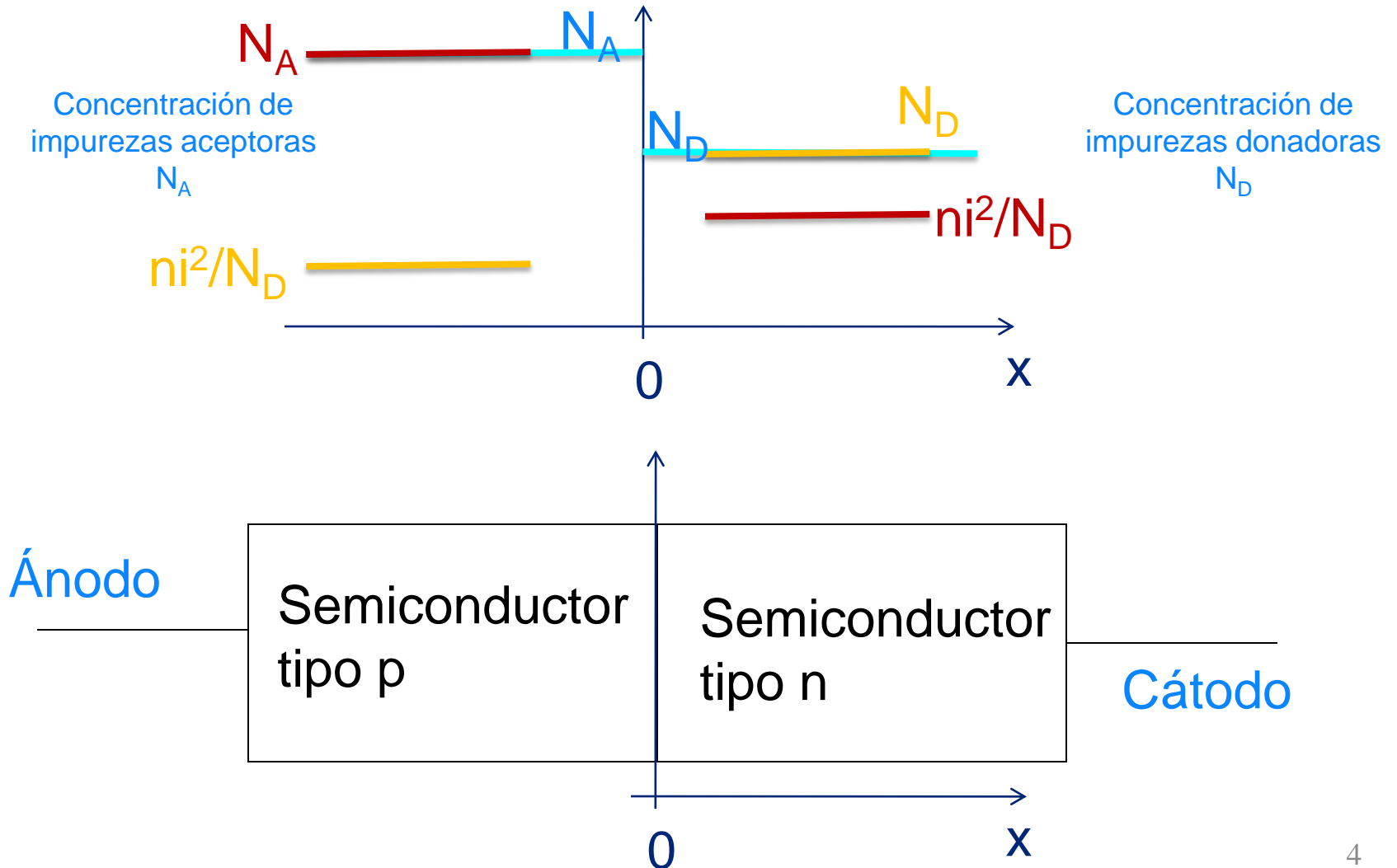

4.1 Estructura

Condensadores en el Diodo:

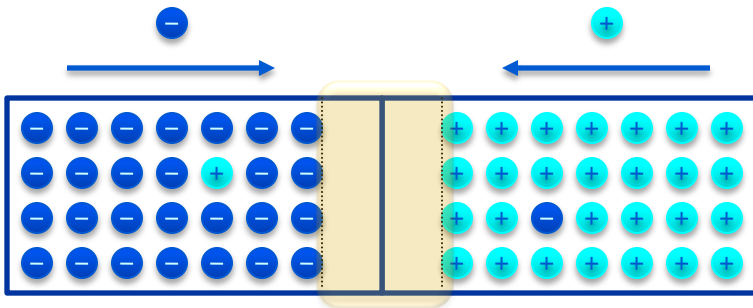

$$C_j = \frac{C_{jo}}{\left[1 - \frac{V}{\phi_o}\right]^m} \quad [F]$$

$$C_{jo} \equiv A \cdot \sqrt{\frac{q\epsilon_{Si}}{2} \frac{N_A N_D}{N_A + N_D}} \quad [F/m^2]$$

$$C_{eq} = \frac{C_{jo}\phi_o}{(V_2 - V_1)(1-m)} \left[\left(1 - \frac{V_2}{\phi_o}\right)^{1-m} - \left(1 - \frac{V_1}{\phi_o}\right)^{1-m} \right]$$

Capacidad equivalente de gran señal

4.1 Estructura

Funcionamiento en Polarización:

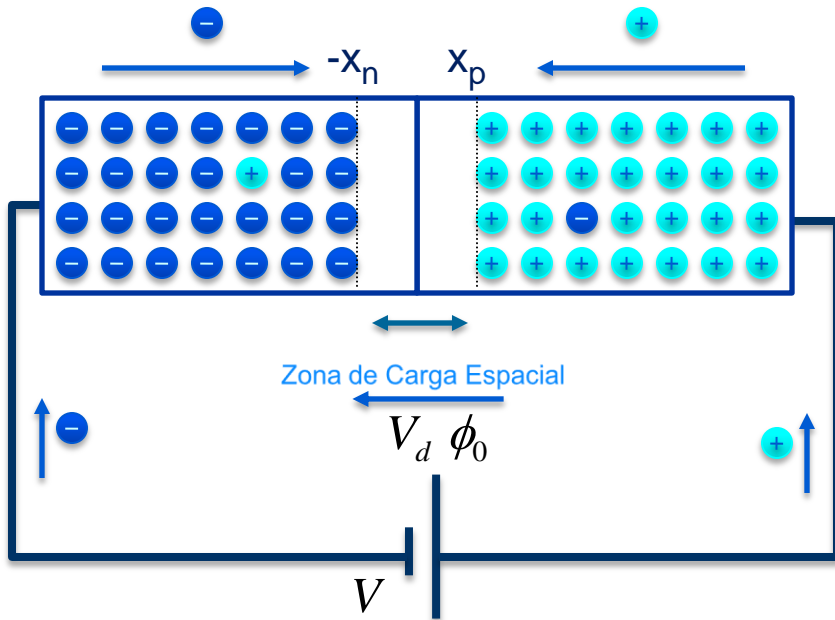

Ley de Boltzman:

$$p_1 = p_2 e^{V_{21}/V_{Te}}$$

$$n_1 = n_2 e^{-V_{21}/V_{Te}}$$

$$p_{no} = p_{po} e^{-\phi_0/V_{Te}}$$

$$n_{po} = n_{no} e^{-\phi_0/V_{Te}}$$

$$p_n(-x_n) = p_p(x_p) e^{-(\phi_0 - V)/V_{Te}} \approx p_{p0} e^{-(\phi_0 - V)/V_{Te}} = p_{n0} e^{V/V_{Te}}$$

$$n_p(x_p) = n_n(-x_n) e^{-(\phi_0 - V)/V_{Te}} \approx n_{n0} e^{-(\phi_0 - V)/V_{Te}} = n_{p0} e^{V/V_{Te}}$$

Ley de la Unión:

4.1 Estructura

Funcionamiento en Polarización:

Aplicación de $V > 0$ (Zona Directa)

$$p_n(-x_n) = p_{p0} e^{-(\phi_0 - V)/V_{Te}} = p_{n0} e^{V/V_{Te}} \quad \text{Inyección de portadores}$$

$$n_p(x_p) = n_{n0} e^{-(\phi_0 - V)/V_{Te}} = n_{p0} e^{V/V_{Te}}$$

Sólo tenemos corriente de difusión

$$J_{dp} = -qD_p \left. \frac{dp}{dx} \right|_{x=-x_n}$$

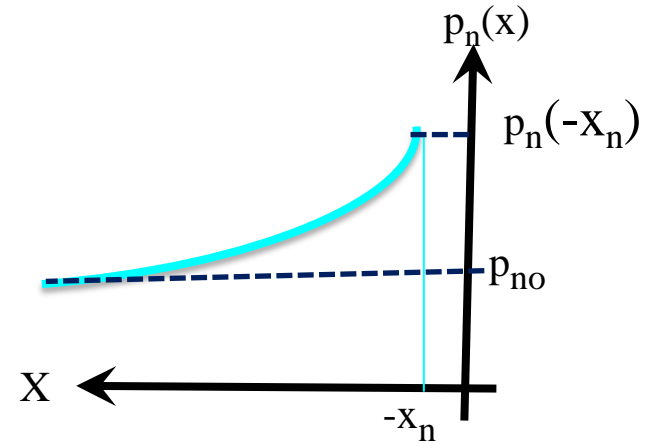

$$p'_n(x) = p'_n(-x_n) e^{-\frac{(x+x_n)}{L_p}} = [p_n(-x_n) - p_{n0}] e^{-\frac{(x+x_n)}{L_p}} = p_{n0} (e^{V/V_{Te}} - 1) e^{-\frac{(x+x_n)}{L_p}}$$

$$J_{dp}(-x_n) = \frac{qD_p p_{n0}}{L_p} (e^{V/V_{Te}} - 1)$$

$$J_{dn}(x_p) = \frac{qD_n n_{p0}}{L_n} (e^{V/V_{Te}} - 1)$$

4.1 Estructura

Funcionamiento en Polarización:

Aplicación de $V > 0$ (Zona Directa)

$$I = qA \left[\frac{D_p p_{n0}}{L_p} + \frac{D_n n_{p0}}{L_n} \right] (e^{V/V_{Te}} - 1) \quad \text{(Es válida también para } V < 0)$$

$$I = I_s (e^{V/V_{Te}} - 1)$$

⏏ $I_s \equiv$ Corriente Inversa de Saturación

$$I_s = qA \left[\frac{D_p p_{n0}}{L_p} + \frac{D_n n_{p0}}{L_n} \right] = qA n_i^2 \left[\frac{D_p}{L_p N_D} + \frac{D_n}{L_n N_A} \right]$$

!!! I_s es muy pequeña !!!

4.1 Estructura

Funcionamiento en Inversa:

Aplicación de $V < 0$

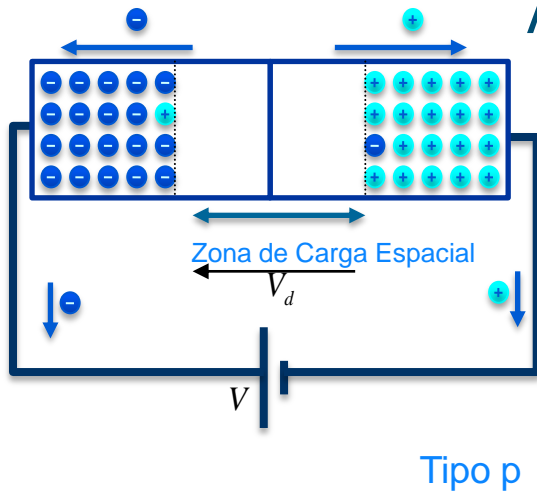

$$I \approx -I_s$$

$$p_n(-x_n) = p_{n0} e^{V/V_{Te}}$$

$$n_p(x_p) = n_{p0} e^{V/V_{Te}}$$

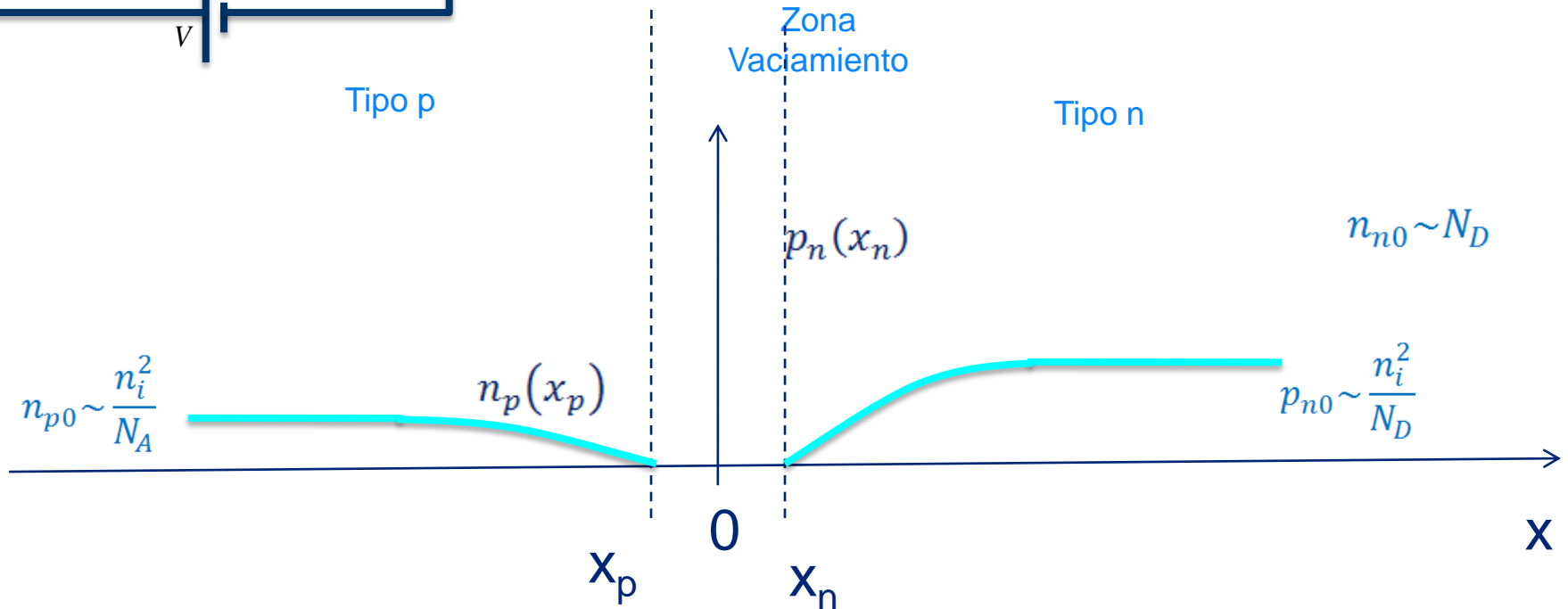

4.2 Modelos

Modelo (Z. Directa y Z. Inversa)

$$I_d = I_S \cdot (e^{\frac{q \cdot V_d}{K \cdot T}} - 1)$$

I_S : Corriente inversa de saturación

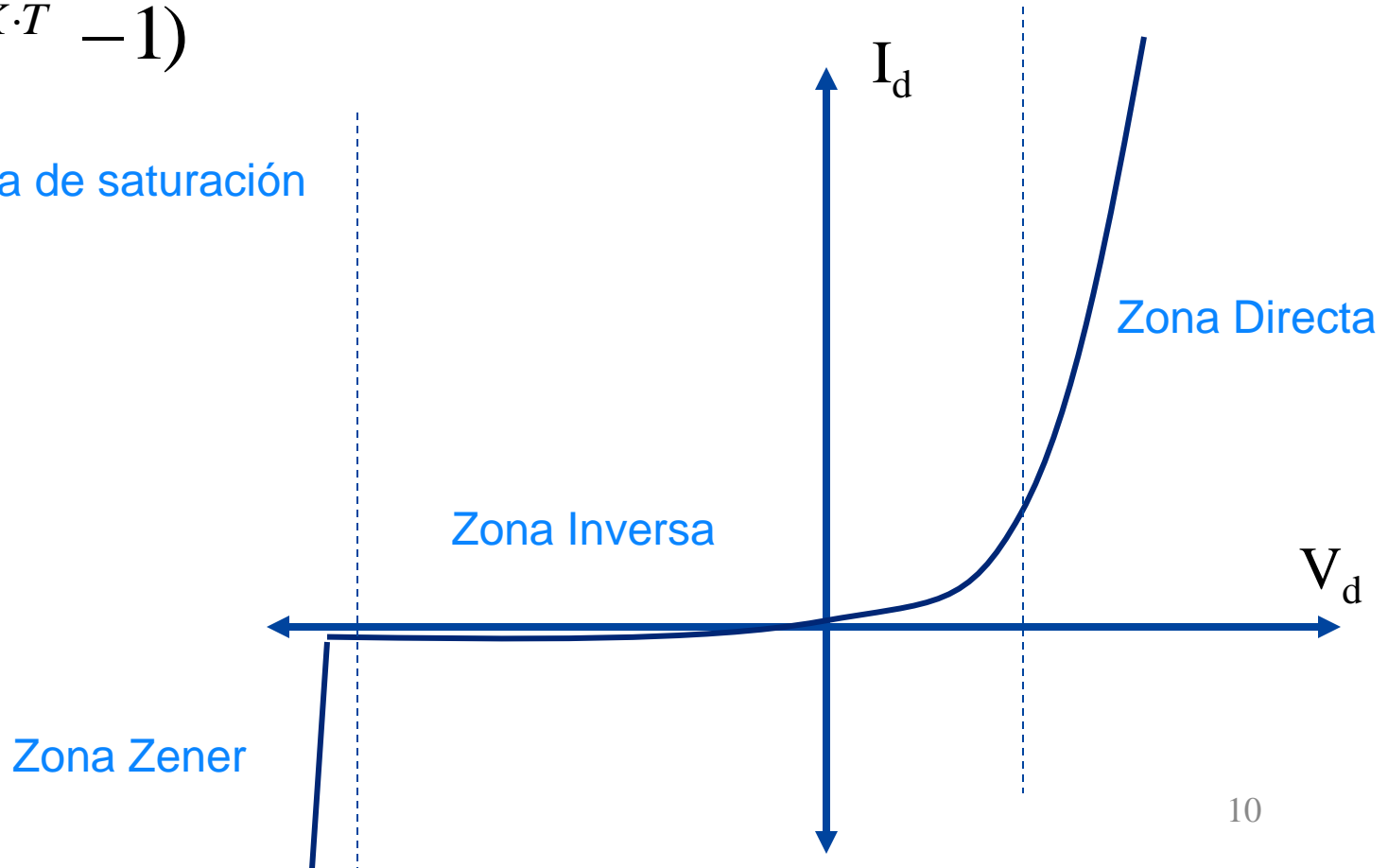

4.2 Modelos

Análisis de Circuitos como dispositivos no-lineales

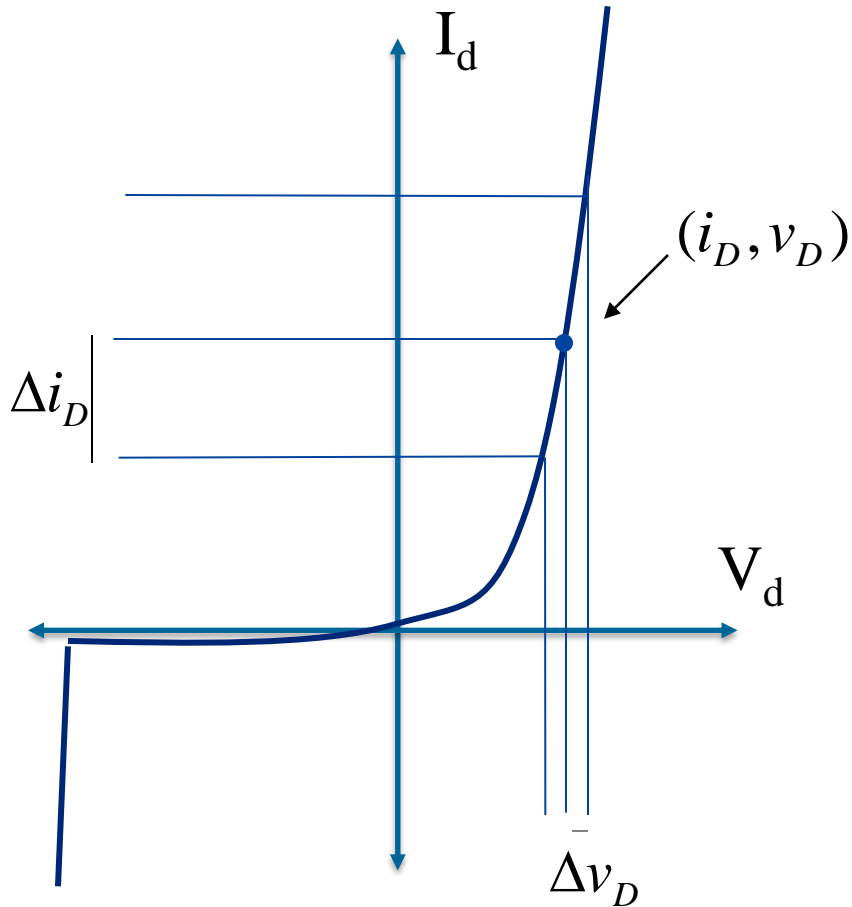

$$I_d = i_D + \Delta i_d$$

$$V_d = v_D + \Delta v_d$$

Análisis del punto de trabajo:
Polarización

Análisis de Pequeña Señal

i_D

Δi_D

v_D

Δv_D

4.2 Modelos

Diodo

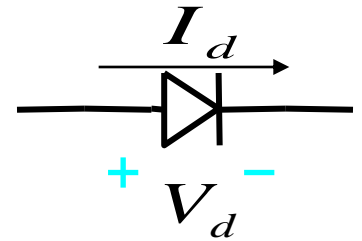

Gráfica

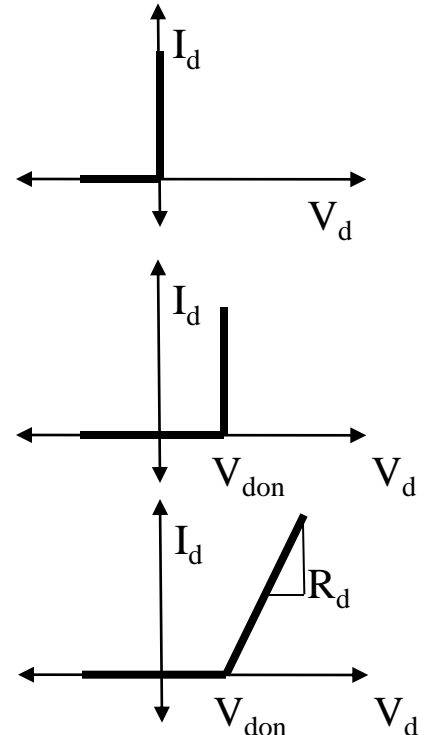

Modelos

Directa

Inversa

Modelo Idealizado

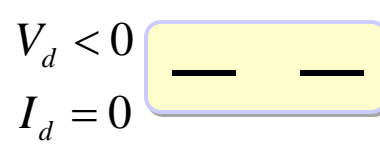
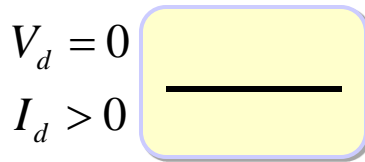

Modelo Idealizado con tensión umbral

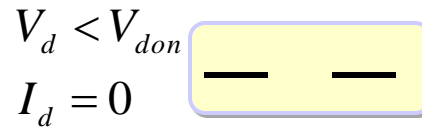
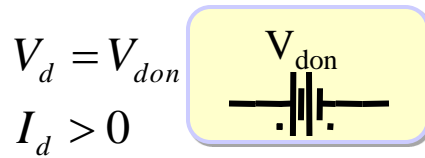

Modelo Linealizado

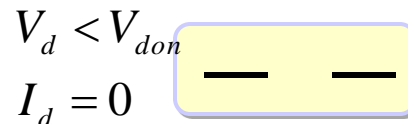
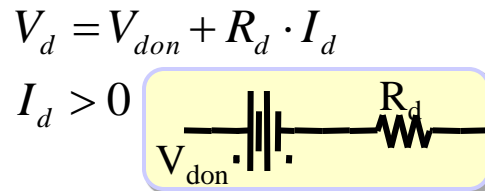

Modelo de pequeña señal

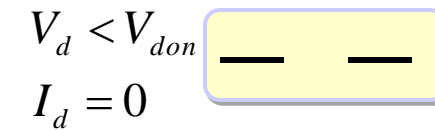
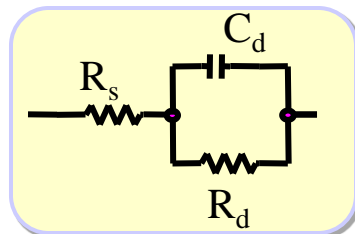

$$R_d = \frac{\partial V_d}{\partial I_d} \quad 12$$

4.2 Modelos

Diodo Zener

Modelos

Directa

Inversa

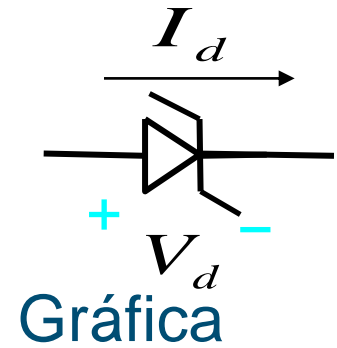

Gráfica

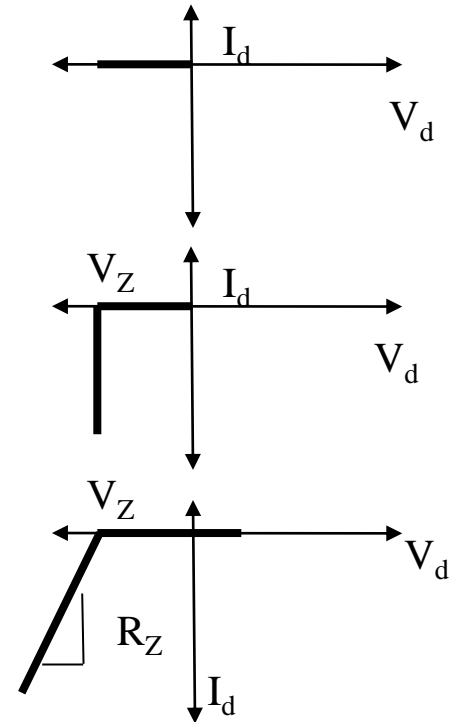

Modelo Idealizado

$$V_d < 0$$

$$I_d = 0$$

$$V_d > -V_Z$$

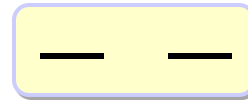

Modelo Idealizado con tensión umbral

$$V_d = -V_Z$$

$$I_d < 0$$

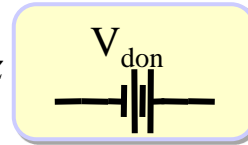

Modelo Linealizado

$$V_d = V_Z + R_d \cdot I_d$$

$$I_d < 0$$

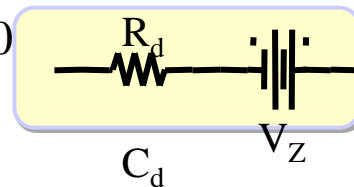

Modelo de pequeña señal

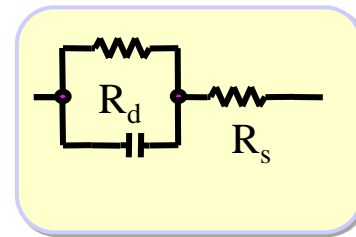

$$R_Z = \frac{\partial V_d}{\partial I_d} \quad 13$$

4.2 Modelo

Curva del diodo (D1N4148)

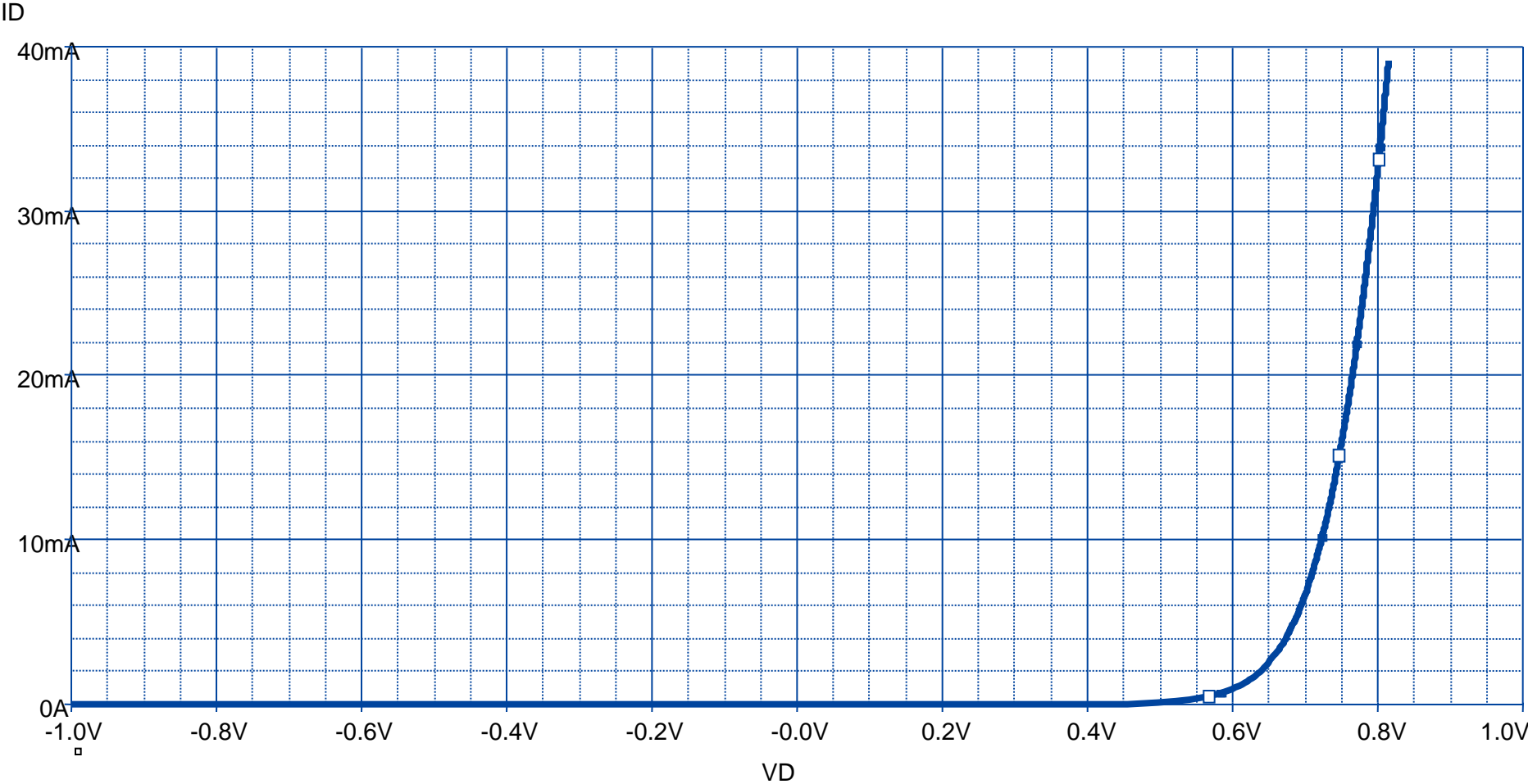

4.2 Modelo

Circuito sencillo con Diodo

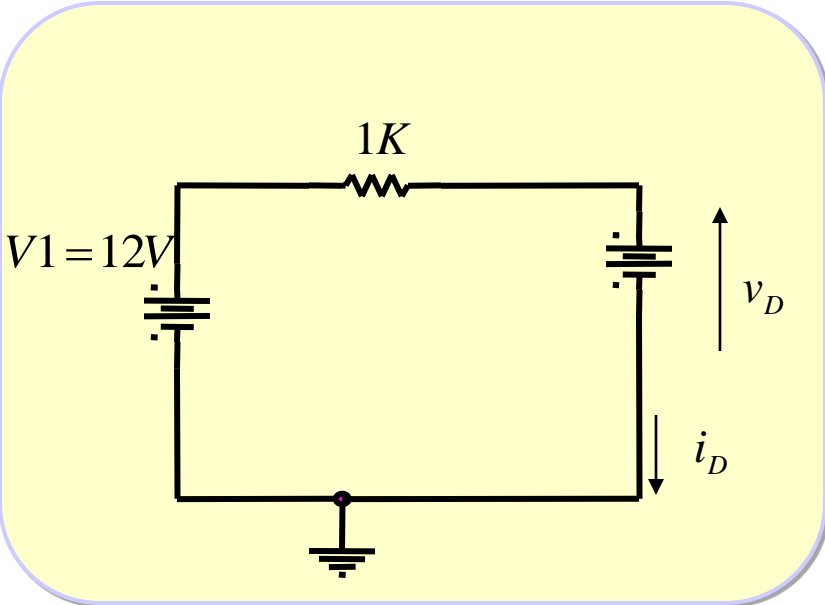

$$i_D = \frac{V1 - v_D}{1K}$$

$$i_D(v_D = 0) = \frac{12 - 0}{1K} = 12mA$$

$$i_D(v_D = 1) = \frac{12 - 1}{1K} = 11mA$$

$$v_D = v_{don} \approx 0.7V$$

$$i_D = \frac{12 - 0.7}{1K} = 11.3mA$$

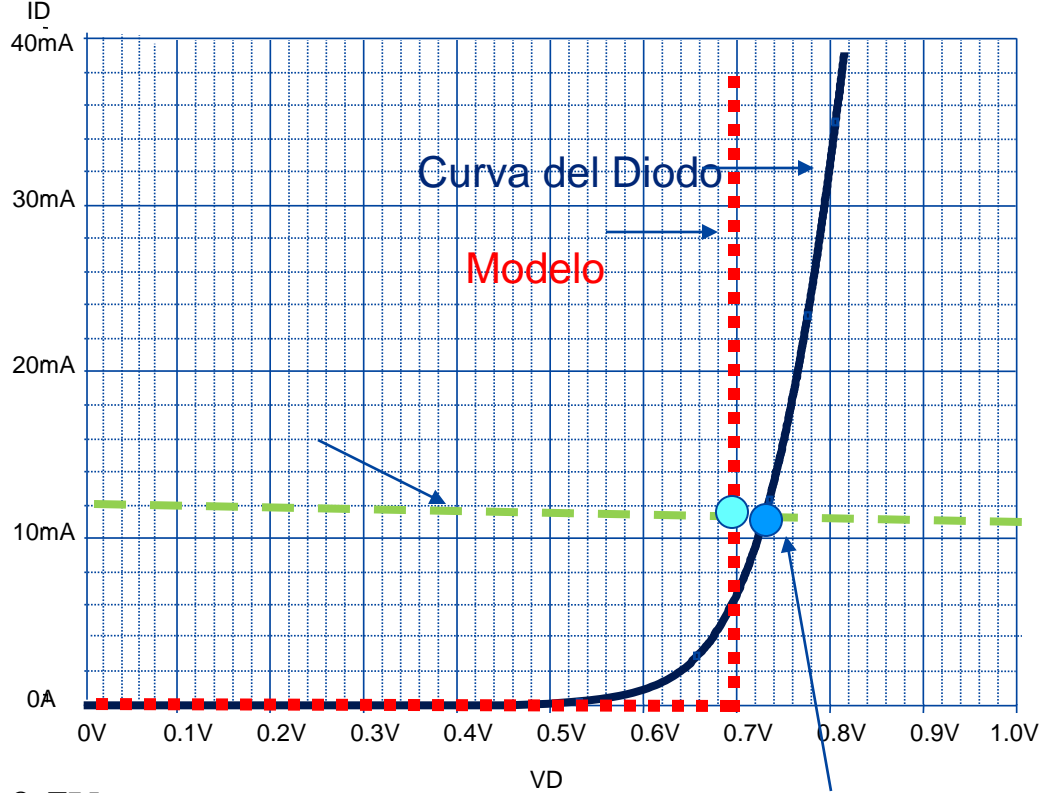

Punto de Trabajo
 $(v_D, i_D) = (0.7295V, 11.3mA)$

4.2 Modelo

Circuito sencillo con Diodo

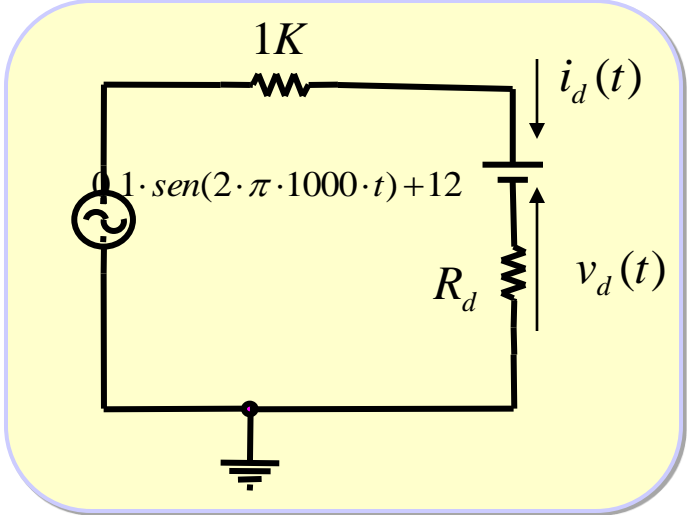

$$i_d = 0.1 \cdot \text{sen}(2 \cdot \pi \cdot 1000 \cdot t) \text{mA}$$

$$v_d = 0.5 \cdot \text{sen}(2 \cdot \pi \cdot 1000 \cdot t) \text{mV}$$

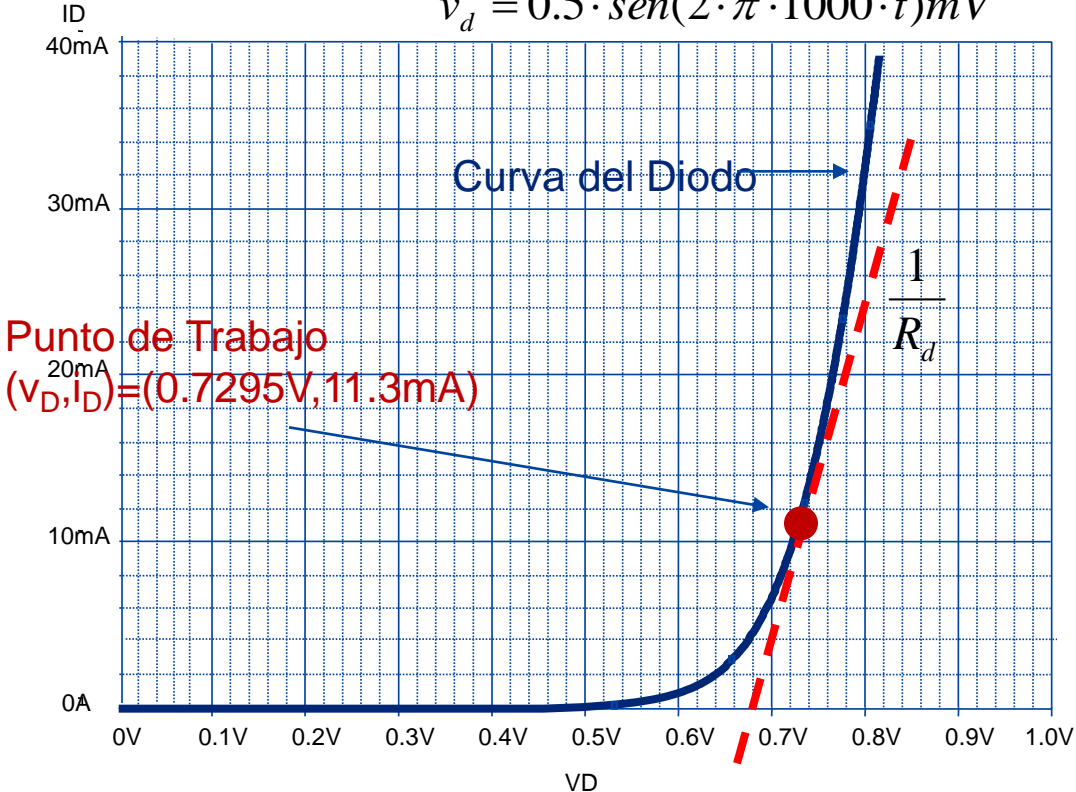

Punto de Trabajo
 $(v_D, I_D) = (0.7295\text{V}, 11.3\text{mA})$

$$i_d = \frac{V2 - v_d}{1K} = \frac{V2 - v_{don} - R_d \cdot i_d}{1K}$$

$$i_d = \frac{V2}{1K + R_d}$$

$$R_d = \left. \frac{\partial v_d}{\partial i_d} \right|_{(v_D, i_D)}$$

$$\frac{1}{R_d} = \left. \frac{\partial i_d}{\partial v_d} \right|_{(0.73, 11.3\text{mA})} = \left. \frac{\partial (I_s \cdot (-1 + e^{\frac{v_d}{K \cdot T/q}}))}{\partial v_d} \right|_{(0.73, 11.3\text{mA})}$$

$$\approx \left. \frac{I_D}{K \cdot T/q} \right|_{(0.73, 11.3\text{mA})} = \frac{11.3\text{mA}}{26\text{mV}} = 0.43$$

4.2 Modelo

Diodo: (Otros tipos de diodos)

Diodo Varicap: Diodos con alta capacidad parásita variable dependiente de la tensión inversa aplicada

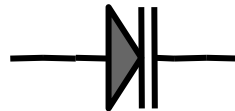

Diodo LED: Diodos capaces de emitir luz cuando están polarizados en directa

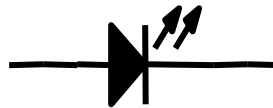

Fotodiodos: Diodos preparados para conducir en inversa una corriente eléctrica proporcional a la luz con la que son iluminados

